



YOUR MUSIC. **YOUR POWER.**

**OWNER'S MANUAL**  
**1 200.4EVOX<sub>2</sub>**

**EVOX<sub>2</sub>**

Introduction .....	3
Package contents .....	3
Safety instructions .....	4
Technologies	
DTM® .....	5
I-Power Supply .....	5
Vibration Absorption System .....	6
Reduced size .....	6
Assembling and disassembling the plastic cover .....	7
Panels description	
Audio inputs and controls .....	8
Power inputs and audio outputs .....	9
Installation sequence .....	10
Electrical dimensioning .....	11
Audio inputs	
RCA inputs .....	11
High Level inputs .....	11
Crossovers set up .....	12
Wiring diagram	
Four channels wiring diagram .....	13
Three channels wiring diagram .....	13
Two channel wiring diagram .....	14
Gain Setting .....	14
Battery connection diagram .....	15
Technical specifications	
Parameters .....	16
Dimensional data .....	16
Additional Information .....	16

## Dear Consumer,

Congratulations, you have just acquired a SoundDigital product of the highest technology and quality, so we thank you for your trust.

SoundDigital products are made with raw materials of the highest quality standards, and the most modern processes, equipment and technology are used in their production.

## IMPORTANT INFORMATION

On this manual you will learn about the product, its features and characteristics, in order to obtain the best result and to be able to enjoy your music with SoundDigital quality and power.

Read this manual carefully and follow precisely all the information contained therein, these are very important and allow your amplifier to work optimally. If you think it is necessary, please do not hesitate to contact our technical support at the following contact:





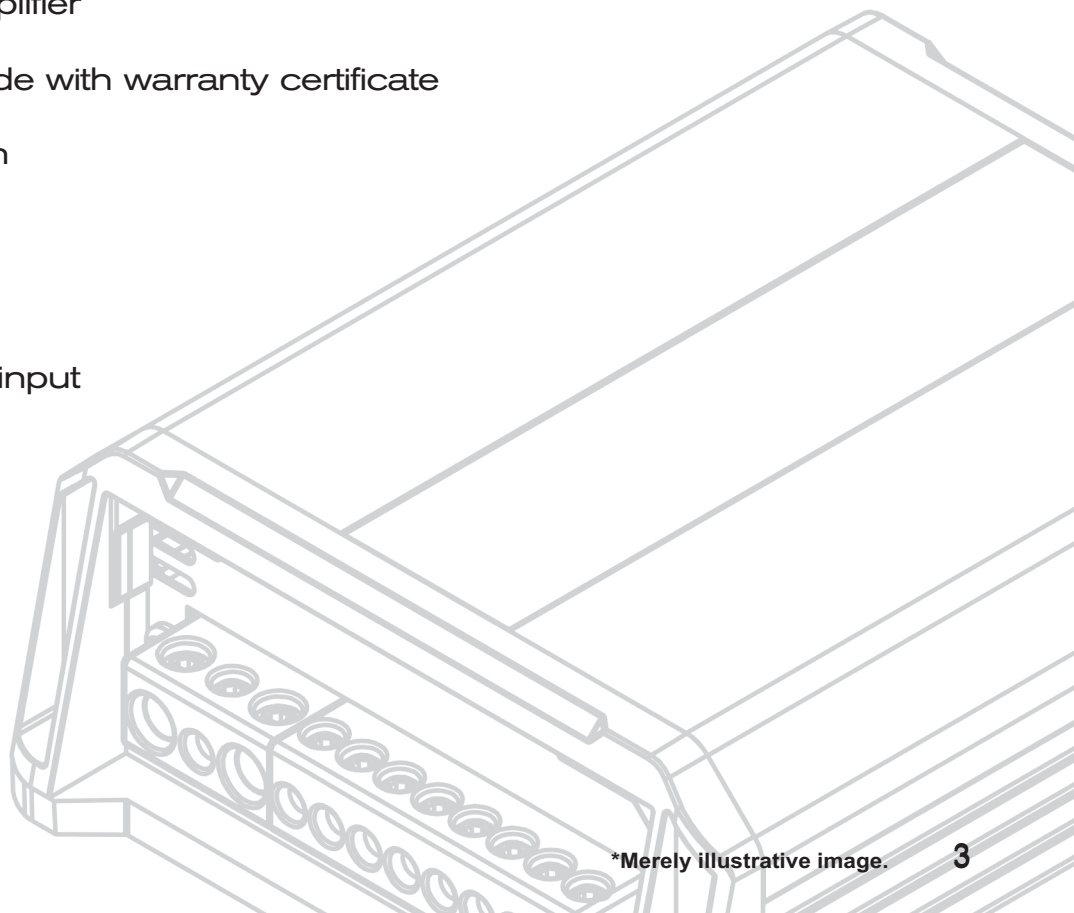

✉ [info@sounddigitalusa.com](mailto:info@sounddigitalusa.com)

## PACKAGE CONTENTS

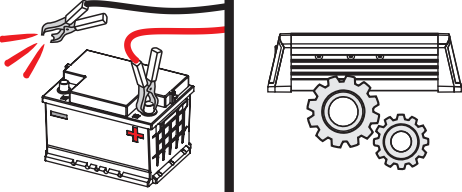
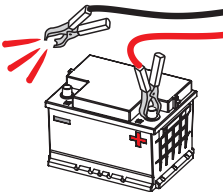
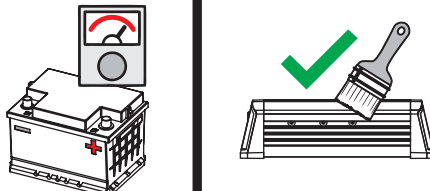
- 01 **1200.4 EVOX2** amplifier
- 01 Quick installation guide with warranty certificate
- 01 Allen wrench 2.0mm
- 01 Allen wrench 2.5mm
- 01 Allen wrench 3.0mm
- 02 Cables for high level input
- 01 Promotional sticker

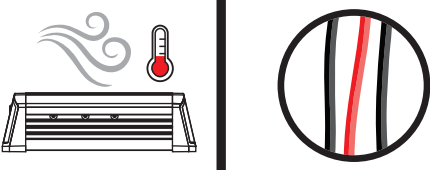
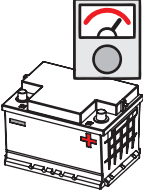
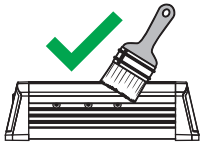

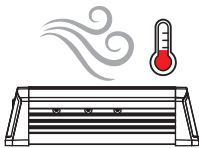
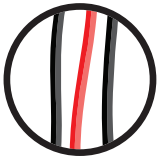
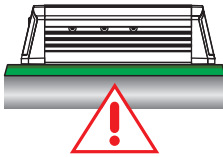
To avoid injury to the user or damage to the amplifier, read all safety instructions written on this manual.

<p>The installation of this product must be done by a qualified professional. In case of any doubt, please contact our technical support;</p>		 <p>When passing cables through metallic walls, use rubber O-rings to avoid cable cutting and short-circuits;</p>
<p>Before proceeding with the installation of any electric equipment on your vehicle, unplug the negative (-) terminal of the battery to avoid fires, injuries or damages;</p>		 <p>Make sure that the chosen location for the amplifier installation does not affect the operation of the vehicle;</p>
<p>Use your sound system safely. The continuous exposure to sound pressures over 85dB may cause irreversible hearing damage;</p>		 <p>This product may reach temperatures over 60°C (140°F). Make sure it is cold before touching it;</p>
<p>This equipment is for use in automotive DC voltage batteries between 12.6 and 14.4 volts. Before installing the equipment, check voltage of the batteries;</p>		 <p>Clean the amplifier periodically with brush or dry cloth to assure the thermal efficiency of the heatsink;</p>
<p>Do not install the amplifier in places exposed to water, dirt or humidity;</p>		 <p>Be careful when making holes in the vehicle. Make sure you are not making holes in the fuel tank, brake lines or electrical cables of the vehicle;</p>
<p>Choose a ventilated place to install the amplifier and avoid blocking the side ventilation windows;</p>		 <p>Make sure the cables are properly secured throughout the installation;</p>
<p>Fix the amplifier properly and firmly. Avoid fixing to metallic parts of the vehicle, as this procedure may cause ground looping (noise);</p>		 <p>Wear gloves, safety glasses and all necessary PPE during the installation of Soundigital amplifiers.</p>



**Warning!**

THIS "WARNING" SIGN ALERTS THE USER OF IMPORTANT INFO. NOT FOLLOWING THESE INSTRUCTIONS MAY CAUSE INJURIES TO THE USER OR DAMAGE TO THE EQUIPMENT.

## DYNAMIC THERMAL MANAGEMENT - DTM®

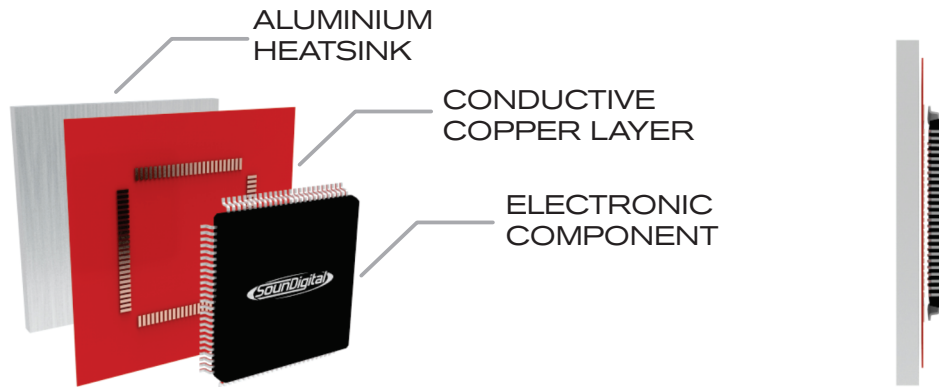

The **DTM**\* is a dynamic thermal recovery system which always maintains a high efficiency of the amplifier by accelerating the thermal exchange of electronic components with the heatsink.

*\*Patent required.*

## ULTRA COMPACT PCB

An intelligent layout, with great use of the PCB area and the use of modern components with reduced structure guarantee **SounDigital** products a compact design, at the same time robust and with excellent thermal efficiency.

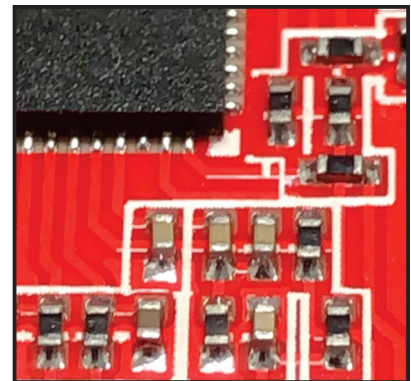

## I-POWER SUPPLY

SounDigital amplifiers are known for their low consumption of battery, and this feature was improved on the **EVOX2 Line**. The new **I-POWER SUPPLY** is even more modern, which replaces the old toroidal transformers by a new generation of "E-E" core transformers delivers efficiency above 90%\*, ensuring more hours of sound without battery recharge.

*\*Efficiency measured at power supply only.*



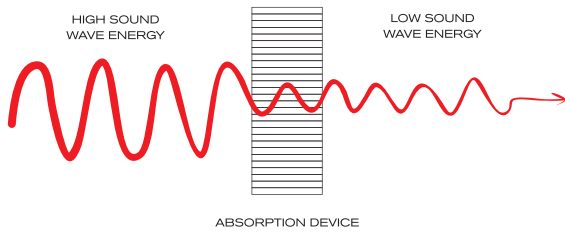

## VIBRATION ABSORPTION SYSTEM - VAS®

Our VAS® Technology reduces all impact caused by vibration on the electronic circuit board. This can include road vibration and even vibration caused by sound waves, increasing the reliability of our amplifiers.

## REDUCED SIZE

The technology used in our amplifiers bring both high performance and power into a compact chassis, providing flexible installation solutions for vehicles with limited space.

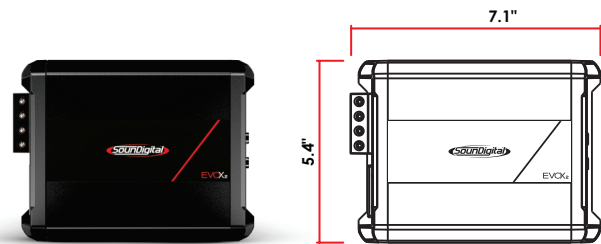

# FULL RANGE

## AMPLIFIER

## FULL RANGE

The **1200.4 EVOX2** amplifier is a versatile product that cover the entire audible frequency range, any type of loudspeaker or music program.

The plastic covers are used to finish off and hide the amplifier's fixing screws. To disassemble and assemble them, follow the instructions below.

## DISASSEMBLING OF THE PLASTIC COVER

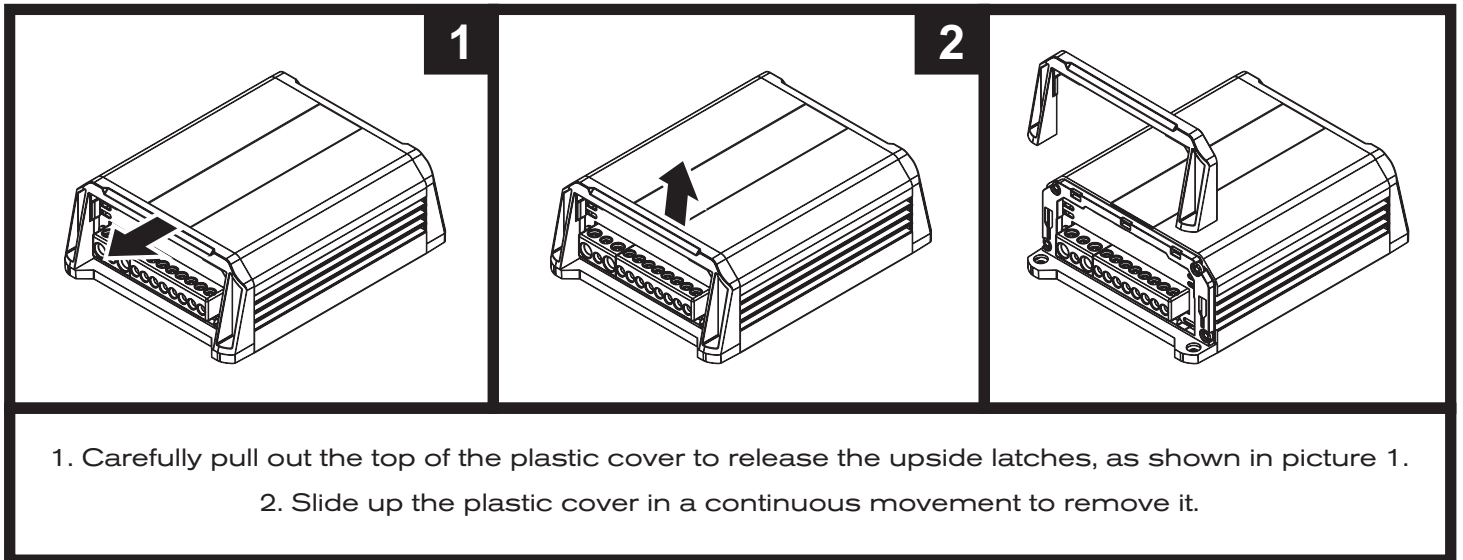

\*Merely illustrative images.

## ASSEMBLING THE PLASTIC COVER

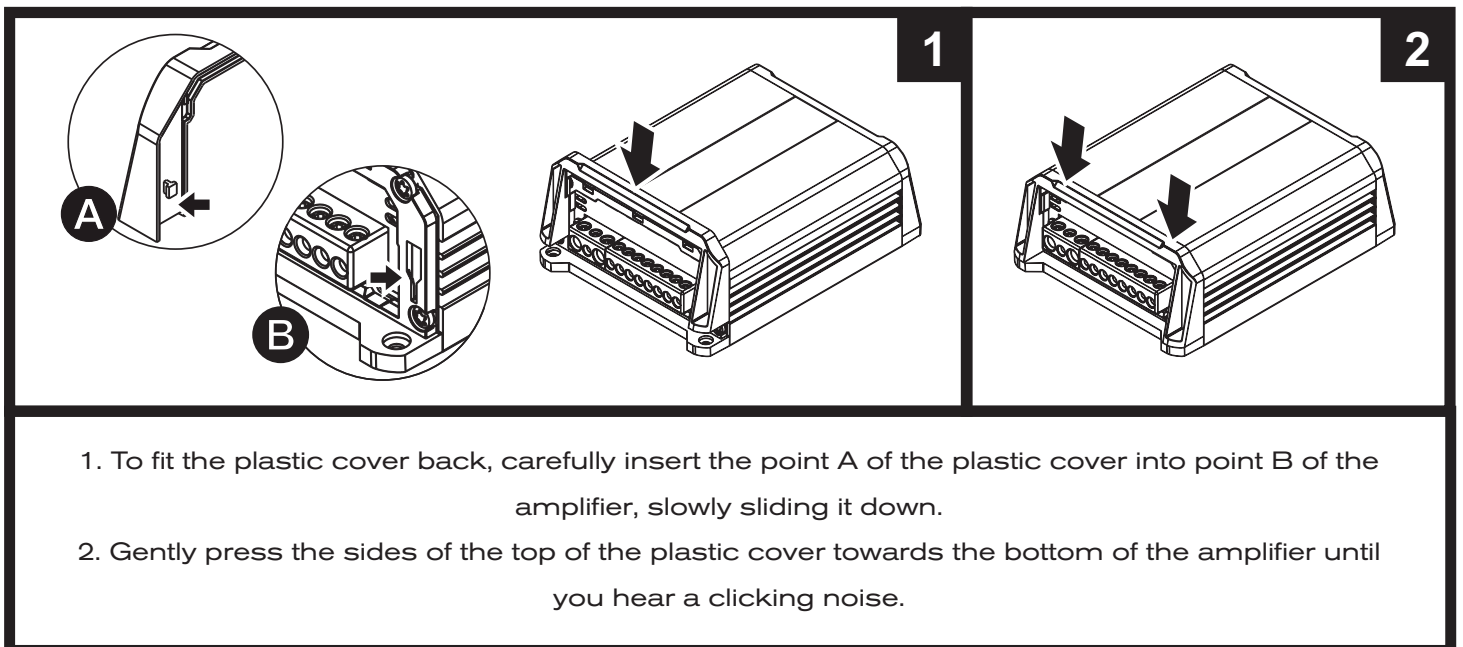

\*Merely illustrative images.

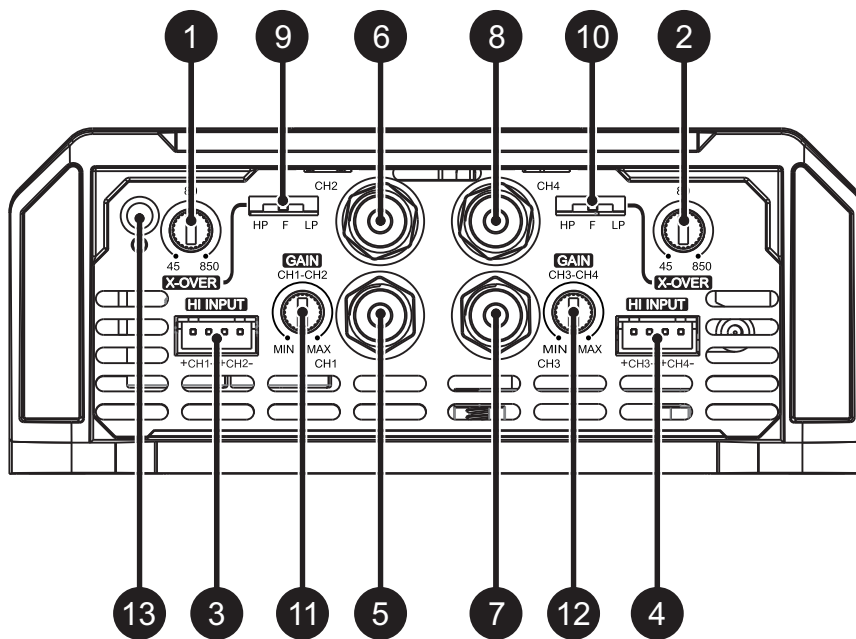

1	CH1/CH2	Variable crossover control – 45Hz ~ 850Hz
2	CH3/CH4	Variable crossover control – 45Hz ~ 850Hz
3	CH1/CH2	Audio input – High Level
4	CH3/CH4	(To connect to the speaker output of the head unit)
5	CH1	Variable Gain control
6	CH2	Audio inputs – RCA connectors
7	CH3	Audio inputs – RCA connectors
8	CH4	Audio inputs – RCA connectors
9	CH1/CH2	Crossover Switch
10	CH3/CH4	High Pass – Full – Low Pass
11	CH1/CH2	Variable Gain control
12	CH3/CH4	Variable Gain control
13	Blue	"POWER ON" LED indicator



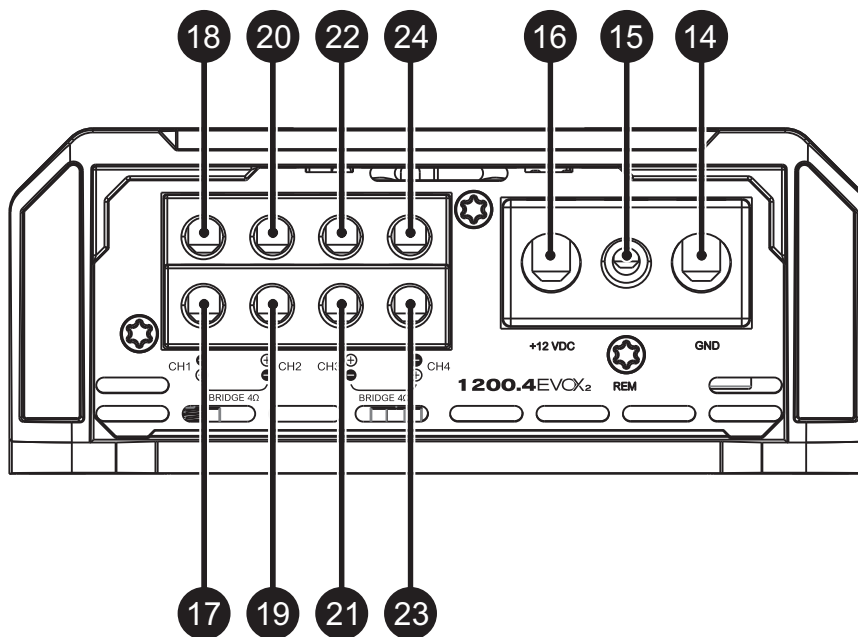

14	-	Negative power supply connector (GND)
15	-	Remote power supply connector (REM)
16	-	Positive power supply connector (+12VDC)
17	CH1	Positive speaker connector (+)
18		Negative speaker connector (-)
19	CH2	Negative speaker connector (-)
20		Positive speaker connector (+)
21	CH3	Negative speaker connector (-)
22		Positive speaker connector (+)
23	CH4	Positive speaker connector (+)
24		Negative speaker connector (-)



BEFORE PROCEEDING WITH THE INSTALLATION, UNPLUG THE NEGATIVE TERMINAL FROM ALL OF THE BATTERIES, TO AVOID FIRE, DAMAGE TO THE AMPLIFIER AND THE USER HIMSELF.

**Warning!**

- Fix the amplifier so that the connectors can be easily accessed;
- Install the power cables in the vehicle properly, starting from the battery to the fuse holder or circuit breaker, use the cable with the appropriate size. Make all connections, install fuse holders or circuit breakers, but without placing the fuses or with the circuit breakers in the "OFF" position;



THE MAXIMUM DISTANCE FOR THE INSTALLATION OF THE FUSE/CIRCUIT BREAKER IS 12 INCHES (30cm) AWAY FROM THE BATTERY.

**Warning!**

- Connect the power cables in to the amplifier, observing the polarity. Connect all the positive cables (+) from the fuse holder or circuit breaker to the positive conector of the amplifier and all the negative power cables from the batteries to the negative connector of the amplifier;
- The ground cable must be as short as possible and must be connected to the vehicle chassis and the battery negative;

Remove the paint  
between the terminal  
and chassis

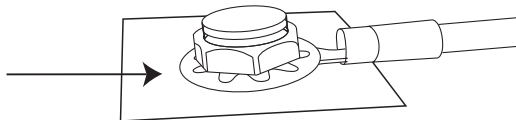

- Install the signal input cables in a proper way, distant from the power cables;
- Connect the RCA or the high level signal input cables to the head unit and amplifiers;
- Install the audio output cables with the appropriate section, distant from the power and audio input cables;
- Connect the audio output cables to the amplifier and speakers respecting the positive (+) and negative (-) polarities;
- Install the remote cable with the power cables, using 1.5mm<sup>2</sup> (15 AWG) cable or thicker;
- Connect the remote power cable to the amplifier's "REM" terminal at the main unit's remote power output (when not using the high level signal inputs);
- Before powering the system, verify all the connections and make sure there are no mistakes or short-circuits on the power and ground cables;
- Reconnect the ground of the batteries;
- Check if the head unit is turned off and then place the fuses in the fuse holders or switch the circuit breakers on;
- Turn on the main unit and the amplifier will turn on the "POWER ON" LED indicating that it is in operation.



**Warning!**

Minimum recommended  
installation distance  
between amplifiers\*.  
1.18in (30mm)

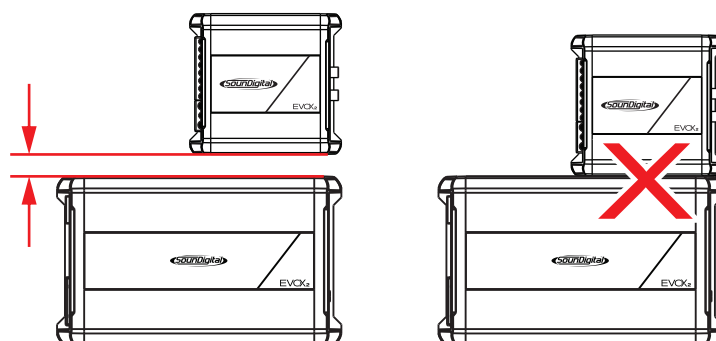

\*For installations with more than one amplifier, second unit not included. Merely illustrative images.

## ELECTRICAL DIMENSIONING

For proper operation of your SounDigital amplifier, you need the proper dimensioning of the electrical system and the cables used.

The table below shows the minimum section of GND cables, +12VDC cables and speaker output cables according to the power generated by the amplifier.

1200 WRMS	POWER CABLE (+12VDC)	16mm <sup>2</sup> (5 AWG)
	GROUND CABLE (GND)	
	SPEAKER CABLE	2 x 2.5mm <sup>2</sup> (13 AWG)

We recommend the use of only OFC (Oxygen Free Copper) cables on the installation of our products.

Copper-clad aluminum wire (CCAW) must not be used.

## AUDIO INPUTS

### RCA inputs

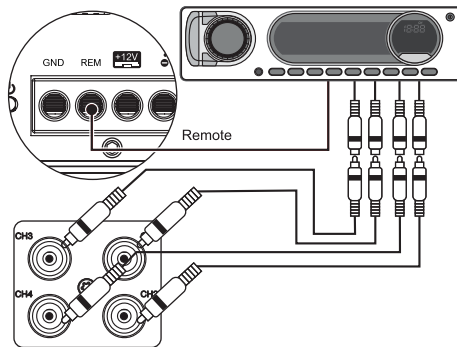

All RCA inputs must be connected for the amplifier to work properly. If the signal source is mono type, use "Y" cable at the input.

### High level signal inputs

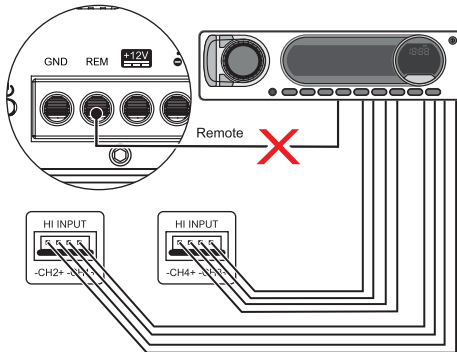

All High level signal inputs must be connected for the amplifier to work properly.

High level input must be used when the main unit does not have RCA outputs.

When High level input is used, no remote connection is required, the amplifier recognizes the audio signal and switches on.

If your source unit is not able to turn on the amplifier through the High level input, the remote input should be connected normally.



**Warning!** RCA AND HIGH LEVEL INPUTS SHOULD NOT BE USED SIMULTANEOUSLY OR YOU MAY DAMAGE THE AMPLIFIER.

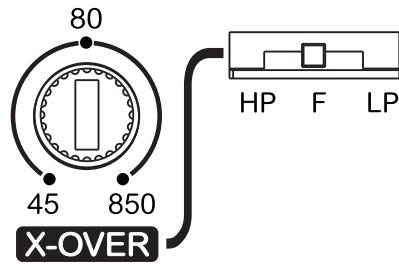

- "F" All the frequencies are reproduced;
- "LP " Set in the variable control on Low Pass Function;
- "HP " Set in the variable control on High Pass Function.

➤ Change the switch to "F" position (Full Range) - All the frequencies will be reproduced.

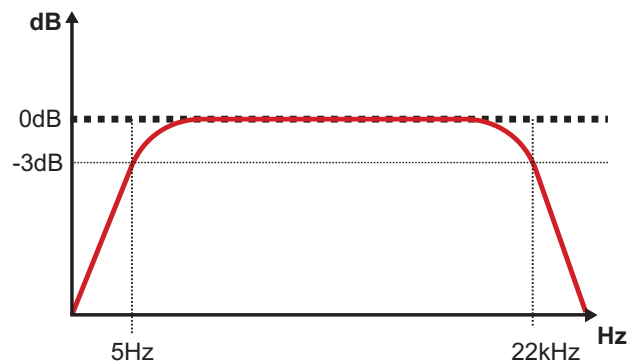

➤ Change the switch to "HP" position - Set in the variable control between 45Hz and 850Hz ("A") where you want to perform the high pass cut filter;

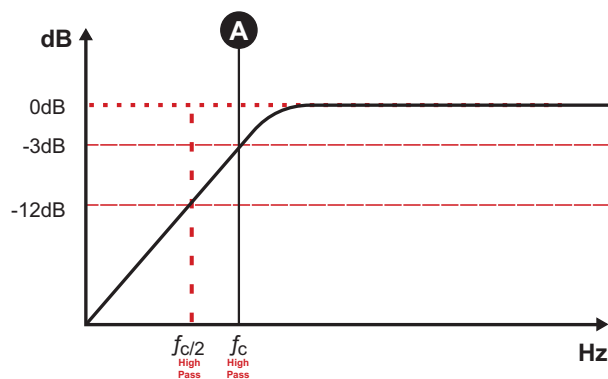

➤ Change the switch to "LP" position - Set in the variable control between 45Hz and 850Hz ("B") where you want to perform the low pass cut filter.

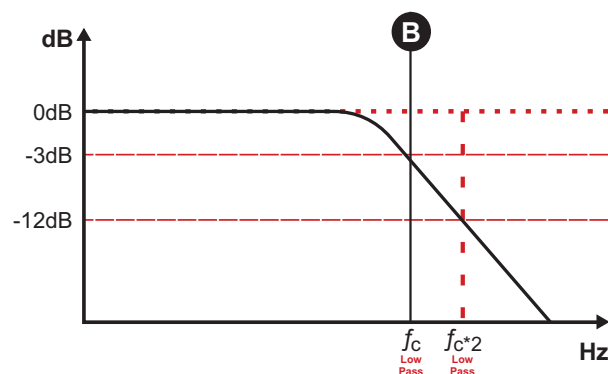

### 4 CHANNELS WIRING DIAGRAM

See "AUDIO INPUTS" on page 11

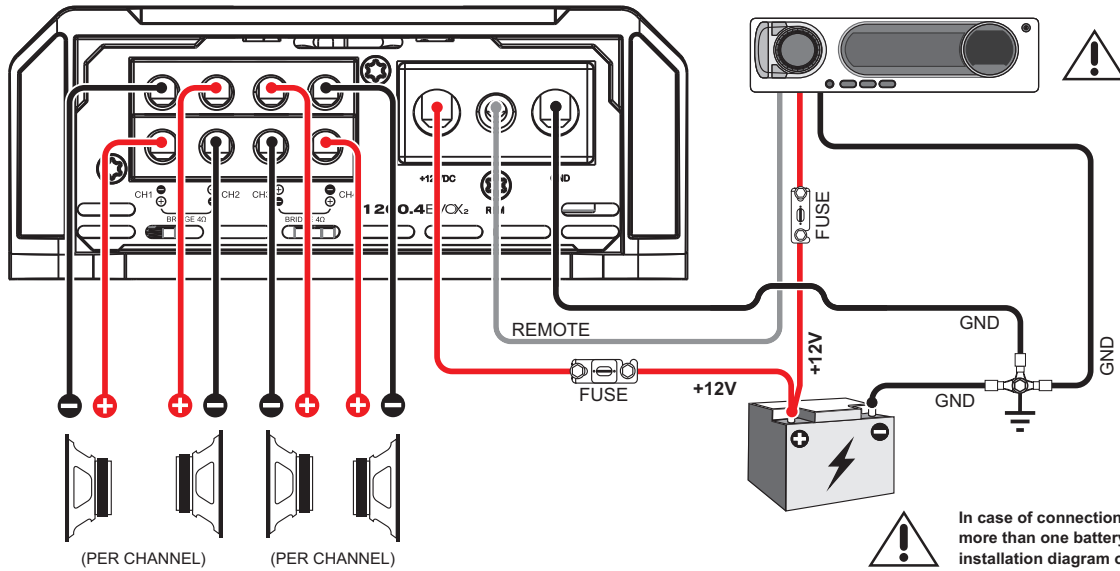

All RCA inputs must be connected for the amplifier to work properly. If the signal source is a mono type, use a "Y" cable at the input.

In case of connections with more than one battery, see the installation diagram on page 15.

Minimum impedance			
Model		Per channel	Bridge
1200.4 EVOX2	2Ω	1Ω	2Ω
1200.4 EVOX2	4Ω	2Ω	4Ω

### 3 CHANNELS WIRING DIAGRAM

See "AUDIO INPUTS" on page 11

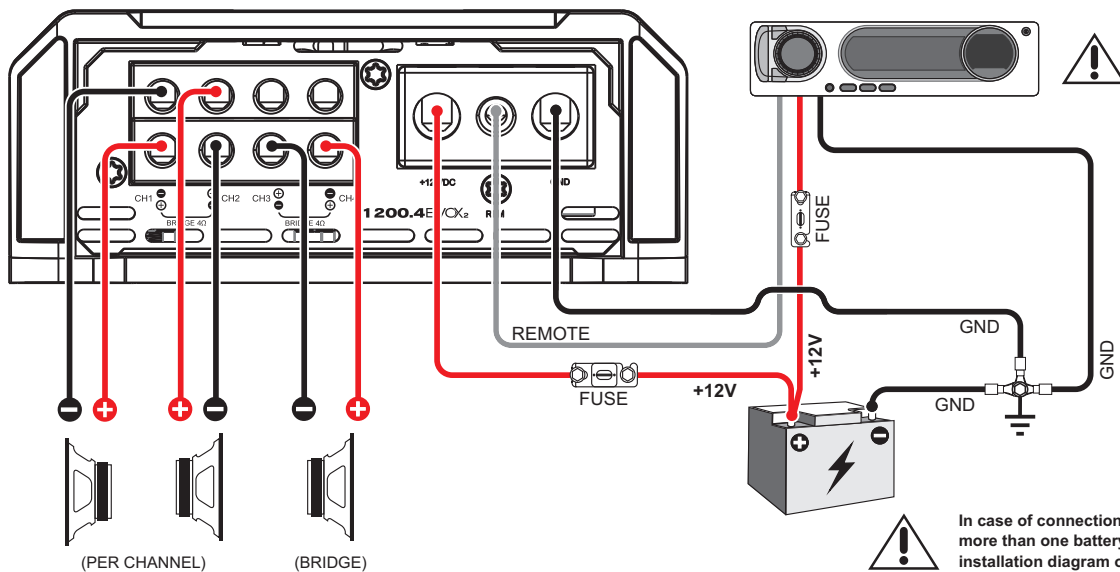

All RCA inputs must be connected for the amplifier to work properly. If the signal source is a mono type, use a "Y" cable at the input.

In case of connections with more than one battery, see the installation diagram on page 15.

Minimum impedance			
Model		Per channel	Bridge
1200.4 EVOX2	2Ω	1Ω	2Ω
1200.4 EVOX2	4Ω	2Ω	4Ω

## 2 CHANNELS WIRING DIAGRAM

See "AUDIO INPUTS" on page 11

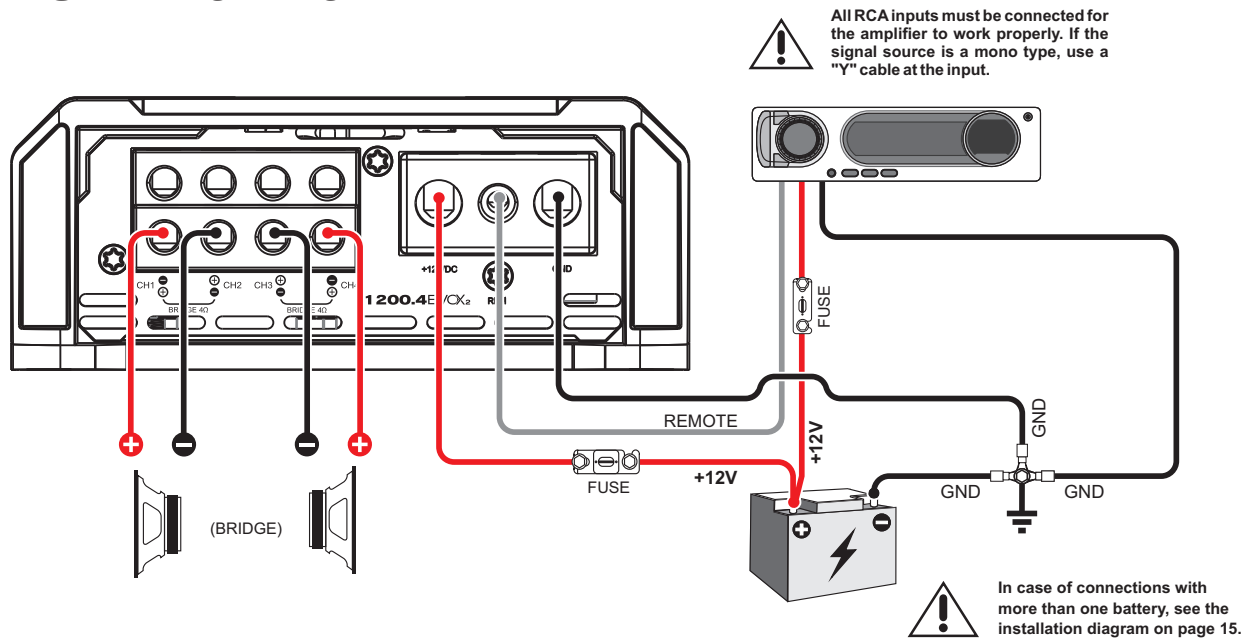

Minimum impedance			
Model		Per channel	Bridge
1200.4 EVOX2	2Ω	1Ω	2Ω
1200.4 EVOX2	4Ω	2Ω	4Ω

## GAIN SETTING

### Necessary equipment:

- Digital AC voltmeter;
- Media with sine wave test tone 60Hz recorded at 0db;
- Screwdriver 1/8" (for gain setting).

### Set up procedure:

- This procedure is the same for both gain controls;
- Turn the gain control all the way down;
- Disconnect the output cables from the amplifier outputs;
- Turn off all processing (bass, treble, loudness, EQ, etc.);
- Set the audio player volume to 3/4 of full volume ;
- Set the audio player fader control to center position (left and right fader controls);
- Set the crossover selector switch in "F";
- Use a 60 Hz sine wave;
- Connect the AC voltmeter to the speaker output connectors of the amplifier. Make sure you test the voltage at the correct connectors (+ and -);
- Increase the gain control until the target voltage is observed with the voltmeter (see the chart below);
- Once you have adjusted the amplifier to the correct voltage output, turn off the source unit and reconnect the speaker(s).

MODEL		STEREO / POWER	BRIDGE / POWER	STEREO OUTPUT VOLTAGE	BRIDGE OUTPUT VOLTAGE
<b>1200.4 EVOX<sub>2</sub></b>	2Ω	1Ω / 300W	2Ω / 600W	17.3V	34.6V
<b>1200.4 EVOX<sub>2</sub></b>	4Ω	2Ω / 300W	4Ω / 600W	24.5V	49.0V

Download the tracks for set up in <https://sounddigitalusa.com/tracks-for-set-up/>



PARAMETERS	1200.4 EVCX <sub>2</sub> 2Ω	1200.4 EVCX <sub>2</sub> 4Ω
Power RMS @ 4Ω**	4 x 131W	4 x 198W
Power RMS @ 2Ω**	4 x 198W	4 x 300W
Power RMS @ 1Ω**	4 x 300W	N/A
Power RMS (Bridge) @ 4Ω**	2 x 396W	2 x 600W
Power RMS (Bridge) @ 2Ω**	2 x 600W	N/A
Frequency Response (-3dB)	5Hz ~ 22kHz	5Hz ~ 22kHz
Low Pass filter (12dB/octave)	45Hz ~ 850Hz	45Hz ~ 850Hz
High Pass filter (12dB/octave)	45Hz ~ 850Hz	45Hz ~ 850Hz
Operating Voltage	8V ~ 16V	8V ~ 16V
SNR	90dB	93dB
Input Sensitivity (RCA)	0.16 ~ 2V	0.16 ~ 2V
Input Sensitivity (High Level input)	1.32V ~ 14.3V	1.32V ~ 14.3V
Current Draw (music)	55A	52A
Current Draw (max.)	110A	105A
Total Efficiency	85%	85%
Damping Factor (@100Hz nominal impedance)	200	200
Power Cable	16mm <sup>2</sup> / 5 AWG	16mm <sup>2</sup> / 5 AWG
Speaker Cable	2 x 2.5mm <sup>2</sup> / 13 AWG	2 x 2.5mm <sup>2</sup> / 13 AWG
Recommended Fuse* (music)	60A	60A
Recommended Battery (minimum)	60Ah	60Ah

\*It is mandatory to install the fuse at a maximum distance of 12 inches from the battery.

\*\*Power at 14.4V @ 60Hz with a maximum THD of 1%.



**\*\*POWER RATING ACCORDING TO CTA-2006 INDUSTRY STANDARDS.**

## DIMENSIONAL DATA

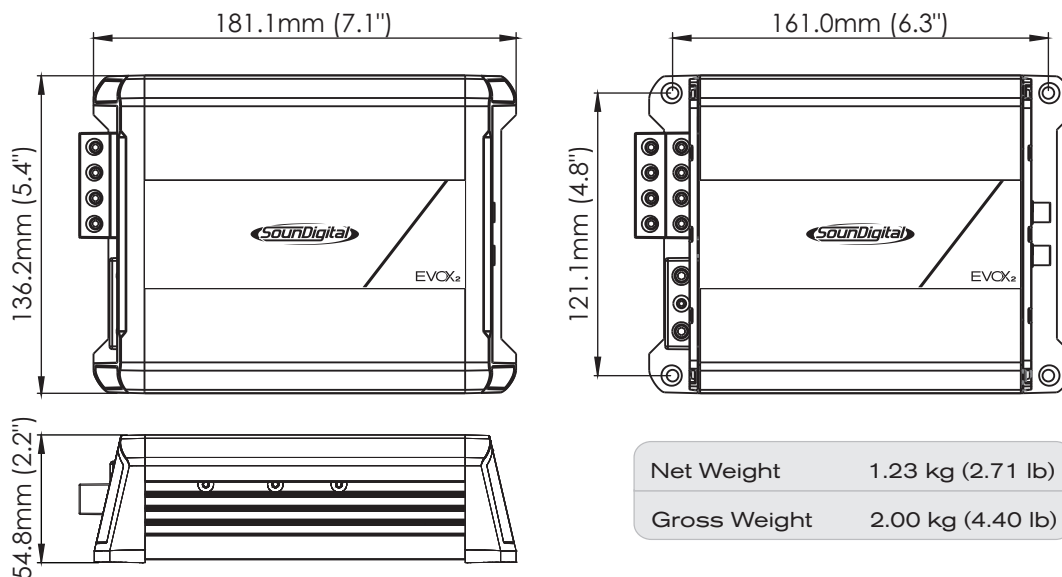

## ADDITIONAL INFORMATION

The values presented are based on measurements performed in SoundDigital's laboratories. All the equipment used in the assays, tests, measurements and gauging of the technical parameters of SoundDigital products were calibrated in certified laboratories, thus ensuring the performance and standard of excellence of the developed products.

The Manufacturing Process may present variations, and the electronic components may also present changes in values in relation to their nominal parameters. Thus, causing small differences between measurements taken. Small variations in the values presented and divulged by SoundDigital are recognized.



Updates of information made in this document will always be published and made available for consumer consultation, free of charge, on the brand's websites. The user is advised to search for the manual in its latest version when necessary.

The images presented in this document are representative and merely illustrative; therefore, they do not necessarily correspond to the actual product/model.





YOUR MUSIC. **YOUR POWER.**

Document revision code: 1000750275-003/APR2023



Consumer  
Technology  
Association™



[WWW.SOUNDIGITALUSA.COM](http://WWW.SOUNDIGITALUSA.COM)



[SOUNDIGITALUSA](https://www.facebook.com/SOUNDIGITALUSA)



[SOUNDIGITALUSA](https://www.instagram.com/SOUNDIGITALUSA)