

OWNER'S MANUAL

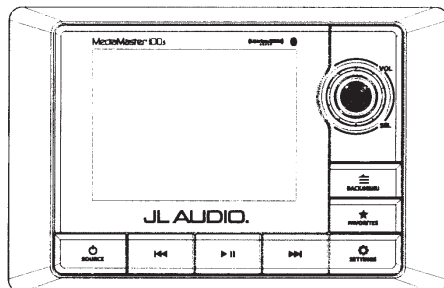

MediaMaster® 100s

*Thank you for purchasing a JL Audio MediaMaster®
Source Unit for your sound system.*

This product has been designed and manufactured to exacting standards in order to deliver years of musical enjoyment. For maximum performance, we highly recommend that you have your MM100s installed by an authorized JL Audio dealer. Your authorized dealer has the training, expertise and installation equipment to ensure optimum performance from this product. Due to the complexity of modern vehicle systems, we do not recommend self-installation unless you have extensive experience in automotive and marine electrical systems. Should you decide to install this product yourself, please take the time to read this manual thoroughly to familiarize yourself with its installation requirements and setup procedures.

If you have any questions regarding the instructions in this manual or any aspect of the product's operation, please contact your authorized JL Audio dealer for assistance. If you need further assistance, please contact the JL Audio Technical Support Department at technical@jlaudio.com or call (954) 443-1100 during business hours.



Protect Your Hearing!

We value you as a long-term customer. For that reason, we urge you to practice restraint in the operation of this product so as to not damage your hearing and that of others in your vehicle. Studies have shown that continuous exposure to high sound pressure level can lead to permanent (irreparable) hearing loss. Mobile sound systems are capable of producing such high sound pressure levels. Please limit your continuous exposure at high volumes. While driving, operate your audio system in a manner that still allows you to hear necessary noises to operate your vehicle/vessel safely (horns, sirens, etc.).

FCC Compliance Statement

This equipment has been tested and found to comply with the limits of Part 15 of the FCC Rules. These limits are designed to provide reasonable protection against harmful interference in a residential installation. This equipment generates, uses and can radiate radio frequency energy and, if not installed in accordance with the instructions, may cause harmful interference to radio communications. However, there is no guarantee that interference will not occur in a particular installation. If this equipment does cause harmful interference to radio or television reception, the user is encouraged to try to correct the interference by one or more of the following measures:

- Reorient or relocate the receiving antenna.
- Increase separation between the equipment and the receiver.
- Connect the equipment to an outlet on a circuit different from that to which the receiver is connected.
- Consult the dealer or an experienced radio/TV technician for help.

Any changes or modifications not expressly approved by the party responsible for compliance could void the user's authority to operate this equipment.

Safety Considerations

- Install this product in a dry, well-ventilated location that does not interfere with your factory-installed systems. If a dry environment is not available, a location that is not exposed to heavy splashing may be used.
- While this product is designed to be water-resistant, it should never be submerged under water or subjected to high-pressure water spray.
- Do not mount this product in an engine compartment or areas of extreme heat. Areas exposed to a heater or hot air should also be avoided.
- Securely mount this product so that it does not come loose in the event of a collision, sudden jolt or as a result of repeated vibrations during normal use.
- Check before drilling to make sure that you will not be drilling into an exterior panel/hull, fuel tank, gas/brake line, wiring harness or other vital system.
- Do not run system wiring outside or underneath the vehicle/vessel. This is an extremely dangerous practice, which can result in severe damage/injury.
- Protect all system wires from sharp edges and wear by carefully routing them, tying them down and using grommets and loom where appropriate. Secure all wiring using cable ties or wire clamps, as needed.
- Do not replace the power wire fuse with one of a different value. Never bypass the fuse.
- Never make power connections with a "live" wire. Failure to make safe, tight, high-integrity connections can result in fire and extensive damage.

Installation Applications

This product is designed for operation with 12 volt, negative-ground electrical systems. Using this product in systems with positive ground and/or voltages other than 12 volts may result in damage to the product and will void the warranty. This product is not certified or approved for use in aircraft.

What's Included

- (1) MediaMaster® MM100s Source Unit
- (1) Power Connections Wire Harness
- (1) Mounting gasket
- (1) Mounting template
- (4) Mounting screws
- (1) Protective sun cover
- (1) User manual

Product Description

The MediaMaster® MM100s is a weather-resistant source unit designed for marine and powersports applications.

**The MM100s includes
the following features:**

- Water-resistant chassis and display (IP66 rated) is built to withstand the elements
- Easy-to-read, high-brightness, 3.5-inch full-color LCD display
- Separate day/night lighting modes with user-defined display brightness, button brightness, remote brightness and display themes
- Intuitive interface with large text for easy legibility while in motion
- Easy-to-use, large controls for marine/powersports applications
- Digital AM/FM tuner with NOAA weather band capability
- RDS (Radio Data System) displays extended FM program info, where available
- SiriusXM-Ready™ (tuner, antenna and subscription sold separately)
- Quick access to 18 of your favorite channels, programmable across all bands
- Bluetooth® v2.1 with the aptX® codec receives top-quality audio from compatible devices with playback control, up to 35 ft. (11 m) away
- USB direct-digital connection accesses music files on your USB storage device or iPhone®
- 1A USB output conveniently charges your phone or portable music player
- 4 Separate audio zones with independent feature and control options deliver outstanding control and flexibility
- 4 Sets of 4V RMS line-level outputs deliver crystal-clear audio signals to your amplifiers
- Auxiliary inputs accept audio signals from any source with line-level outputs
- Zero-clipping audio circuit design, with self-limiting tone controls prevent speaker system damage
- Connect up to three MMR-20 Wired Remotes (sold separately) to add remote control functionality from extended locations

MOUNTING AND INSTALLATION

The diagram below shows a typical mounting procedure into a fiberglass panel. **Always follow proper safety procedures. Wear eye-protection at all times with a dust mask and gloves when cutting.** A mounting template is included to aid in measuring and marking the mounting surface before cutting or drilling.

1. Press along the perforation to remove the center section of the mounting template. (Discard the center section.) The template can be used to verify there is sufficient flat surface area for mounting and as a guide for cutting the opening. Tape the template to the mounting location and mark the surface for cutting the opening and drilling pilot holes.
2. Use a jigsaw or rotary tool to cut an opening in the mounting surface. If necessary, use a file or sandpaper to adjust the opening for proper fitment and smooth the edges.
3. Place the MM100s into the opening and check that the mounting holes remain aligned with the pilot hole marks taken from the template. If not, adjust and mark new holes as necessary.
4. Remove the MM100s and drill four (4) pilot holes in the mounting surface at the pilot hole marks.
5. Peel the adhesive backing from the mounting gasket and affix to the rear of the bezel. Connect all wiring and place the MM100s into the opening.
6. Secure the MM100s using the four (4) stainless steel screws. Press the trim ring onto the front of the MM100s.

! IMPORTANT

Before drilling or cutting, make sure there is adequate space behind the mounting surface to fit the MM100s, including its wire harness.

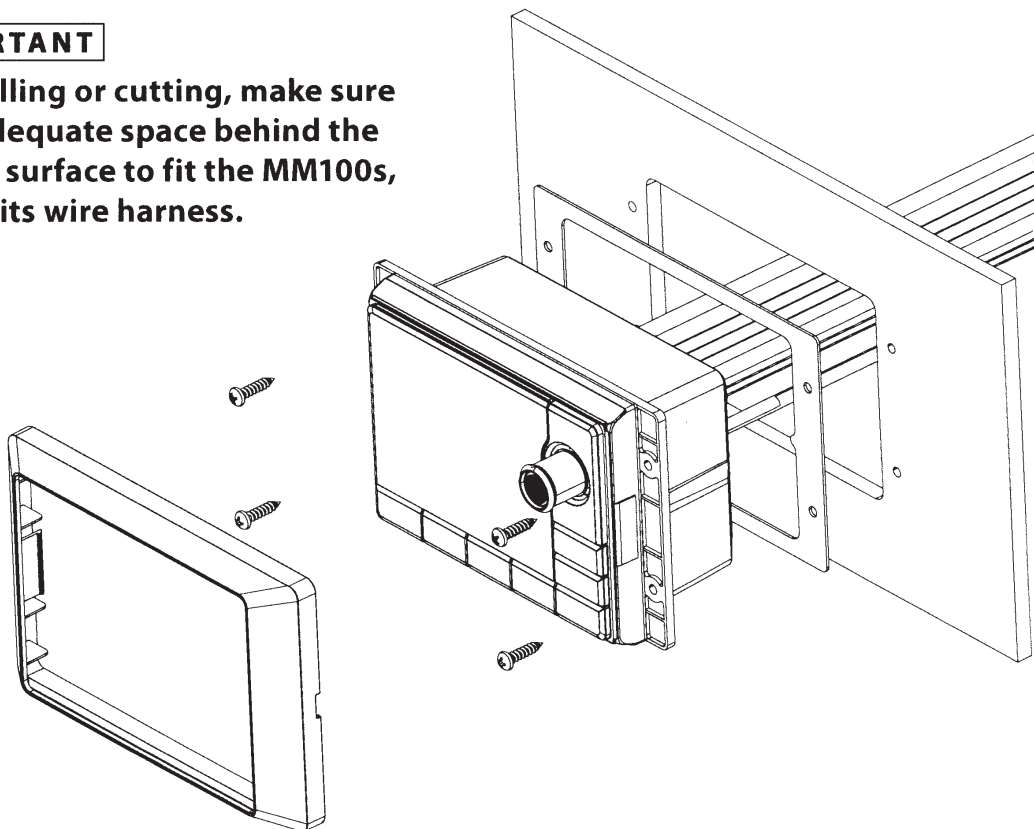

GENERAL CONNECTIONS

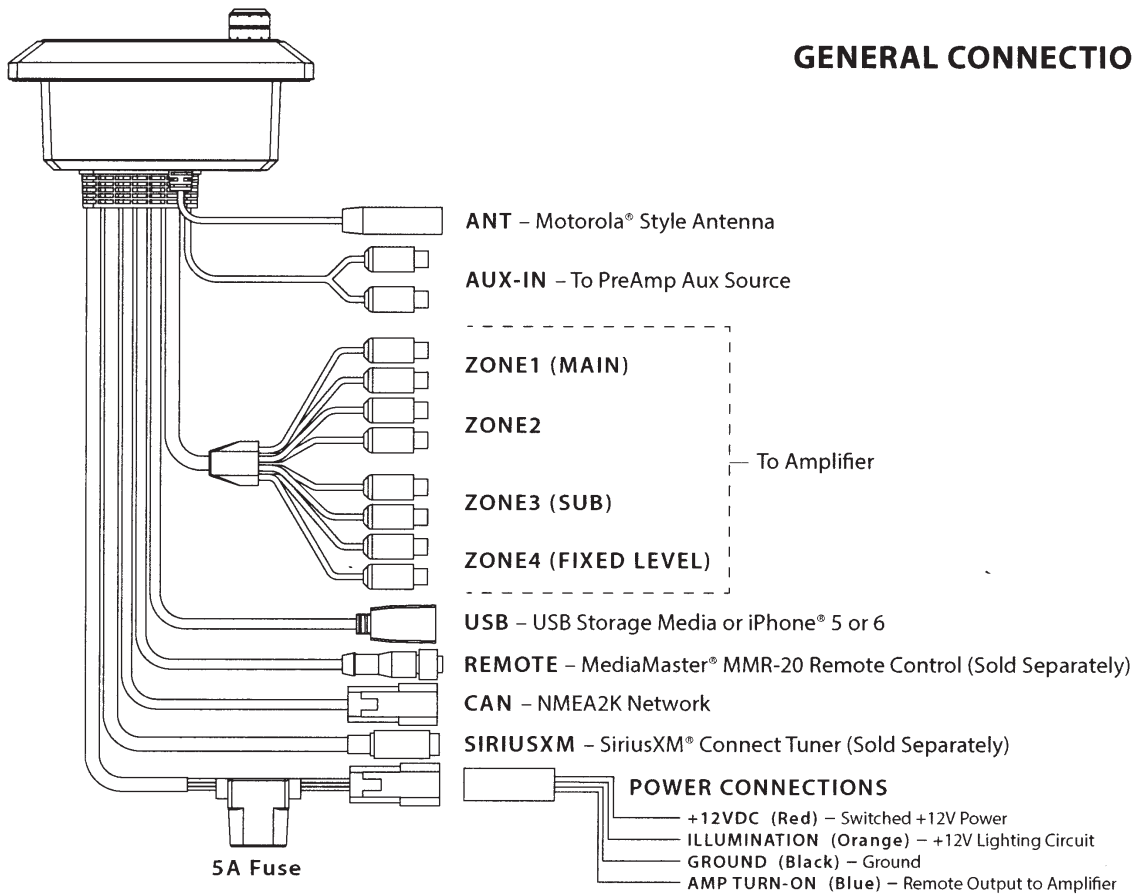

POWER CONNECTIONS

The 4-pin plug with wire leads is used to make power related connections. Make sure to carefully plan the wiring of your system prior to routing wires and making connections. Refer to the table below when making power connections.

! IMPORTANT

Disconnect the NEGATIVE battery post connection and secure the disconnected cable to prevent accidental reconnection. This is an essential safety precaution during installation!

Label	Wire Color	Connection
+12VDC	Red	Connect to a positive (+12V) source. This can be an ignition controlled, accessory circuit or a vessel battery equipped with a main disconnect switch. For added control functionality, we also recommend installing a dedicated toggle switch (not included) at this wire lead's +12V connection point. Always install an appropriate fuse within 18 inches (45 cm) of the +12V connection. If this is the only device using the connection point, use a 5 amp fuse.
GROUND	Black	Connect to a clean metal chassis ground, if available. If no metal chassis ground is available, it may be necessary to connect this to the NEGATIVE battery post. All ground connections (source unit and amplifiers) should be made at the same location to minimize noise.
ILLUMINATION	Orange	Connect to a +12V lighting circuit to automatically switch the illumination to night mode when the lights are activated.
AMP TURN-ON	Blue	This wire provides a positive (+12V) turn-on voltage to activate aftermarket amplifiers.

WIRING HARNESS CONNECTIONS

Harnesses exiting the rear of the unit are used to connect to aftermarket amplifiers/ equipment and media devices. Depending on your specific equipment, you may or may not use all of the connections. **Make sure to plan the layout of your system prior to routing wires and making connections.** Refer to the table below for additional info.





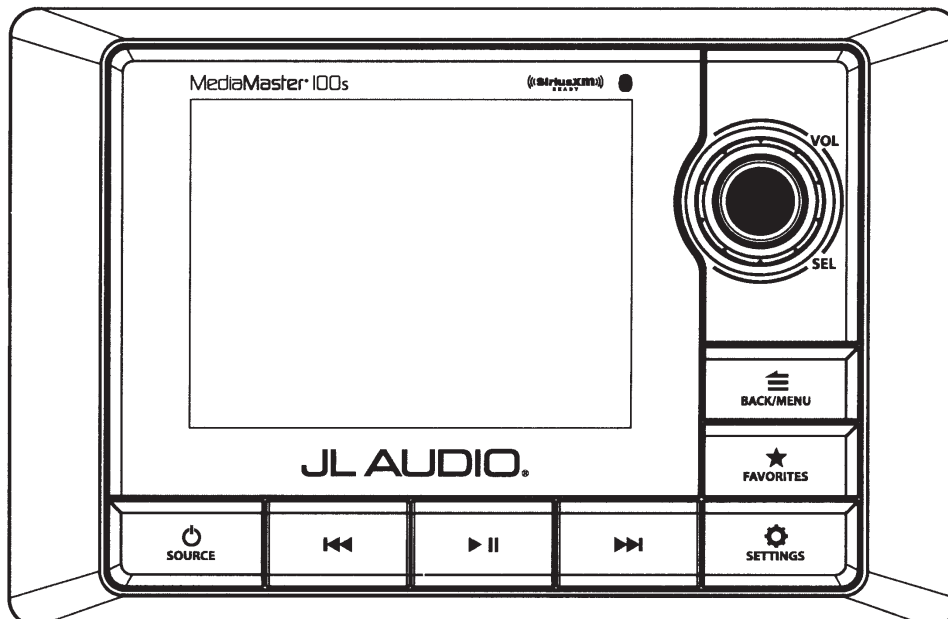



Label	Description	Connection	
ZONE1 (MAIN)	Black RCA	Left Channel Signal Output / Zone 1 (Main)	
	Red RCA	Right Channel Signal Output / Zone 1 (Main)	
ZONE2	Black RCA	Left Channel Signal Output / Zone 2	
	Red RCA	Right Channel Signal Output / Zone 2	
ZONE3 (SUB)	Black RCA	Left Channel Signal Output / Zone 3 (Subwoofer)	
	Red RCA	Right Channel Signal Output / Zone 3 (Subwoofer)	
ZONE4 (FIXED LEVEL)	Black RCA	Left Channel Signal Output / Zone 4 (Fixed level)	
	Red RCA	Right Channel Signal Output / Zone 4 (Fixed level)	
AUX-IN	Black RCA	Left Channel Signal Input / Auxiliary	
	Red RCA	Right Channel Signal Input / Auxiliary	
SiriusXM	10-pin Connector	Connect to SiriusXM® tuner (sold separately)	
ANT	Antenna	Connect to Motorola style antenna	
USB	USB Connector	Connect to USB storage device or iPhone®	
REMOTE	5-pin Threaded Connector	Connect to MMR-20 remote (sold separately)	
CAN	4-pin Deutsch Connector	Connect to NMEA network (requires NMEA 2000 compatible cables, connectors, etc. (sold separately)	

GENERAL CONTROLS



GENERAL CONTROL FUNCTIONS

Below is a list of general commands, including many common operations. The functionality of each control will vary depending on the current source and menu selected.

	Source/ Power	Use this button to turn ON or OFF and to access the source selection menu. <ul style="list-style-type: none"> • Press to turn the unit ON • Press to display the SOURCE: Select menu • Press and hold to turn the unit OFF
	Volume/ Select	Use this knob to adjust volume levels, navigation of menus and make selections. <ul style="list-style-type: none"> • Rotate to adjust volume (Now Playing Screen) • Press and hold to access the Audio Zone Levels menu • Rotate to scroll thru options (menus) • Press to choose/enter (menu options)
	Back/ Menu	Use this button to go back/return and to access the menu options. <ul style="list-style-type: none"> • Press to go back or return to the Now Playing Screen (AM/FM/WB/AUX) • Press to access main menu options (SiriusXM®/USB/Bluetooth®)
	Favorites	Use this button to save, view or edit preset channels (up to 18). <ul style="list-style-type: none"> • Press and hold to store a channel (AM/FM/WB/SiriusXM®) as a preset (star will turn solid) • Press to view your list of stored presets and the Favorites Edit: Select menu.
	Settings	Use this button to access Zone 1 audio settings and main system setting menus. <ul style="list-style-type: none"> • Press to access Zone 1 (MAIN) audio settings • Press and hold to access the System Settings: Main Menu
	Forward	Use this button to make a forward selection. <p>Press to:</p> <ul style="list-style-type: none"> • Tune in the next frequency (AM/FM/WB) or channel (SiriusXM®) • Select the next track (USB/Bluetooth®) <p>Press and hold to:</p> <ul style="list-style-type: none"> • Seek to the next channel (FM/WB) • Skip forward ten frequency steps (AM) • Enter Channel Browse mode (SiriusXM®). • Fast-forward (USB)
	Backward	Use this button to make a backward selection. <p>Press to:</p> <ul style="list-style-type: none"> • Tune in the previous frequency (AM/FM/WB) or channel (SiriusXM®) • Select the previous track (USB/Bluetooth®) <p>Press and hold to:</p> <ul style="list-style-type: none"> • Seek to the previous channel (FM/WB) • Skip backward ten frequency steps (AM) • Enter Channel Browse mode (SiriusXM®). • Fast-rewind (USB)
	Mute/ Pause/ Resume	Use this button to mute audio or pause/resume your music. <ul style="list-style-type: none"> • Press to mute audio (AM/FM/WB/SiriusXM®/AUX) • Press to pause or resume the current selection (USB/Bluetooth®) • Press and hold to access the USB: Play Options menu (USB)

Turning the Unit ON / OFF

1. Press **SOURCE** to turn the unit ON.
2. Press and hold **SOURCE** to turn the unit OFF.

Selecting a Source



1. Press **SOURCE** to access the **SOURCE: Select** menu.
2. Rotate **VOL/SEL** to highlight a desired source; press to select.

Adjusting or Muting Volume

1. Rotate **VOL/SEL** clockwise to increase volume.
2. Rotate **VOL/SEL** counter-clockwise to decrease volume.
3. Press **▶ II** to mute/unmute audio (AM/FM/WB/SiriusXM®) or pause/resume the current selection (USB/Bluetooth®).

Tuner Operation

Tuning selections (AM/FM/WB/SiriusXM®) can be made with the following controls:

	Forward	Press to: <ul style="list-style-type: none">• Tune in the next frequency (AM/FM/WB) or channel (SiriusXM®) Press and hold to: <ul style="list-style-type: none">• Seek to the next channel (FM/WB)• Skip forward ten frequency steps (AM)• Enter Channel Browse mode (SiriusXM®); continue pressing to the desired channel, then press VOL/SEL to select
	Backward	Press to: <ul style="list-style-type: none">• Tune in the previous frequency (AM/FM/WB) or channel (SiriusXM®) Press and hold to: <ul style="list-style-type: none">• Seek to the previous channel (FM/WB)• Skip backward ten frequency steps (AM)• Enter Channel Browse mode (SiriusXM®); continue pressing to the desired channel, then press VOL/SEL to select

Favorites

You may store up to 18 of your preferred stations or channels from your available tuner options (AM/FM/WB/SiriusXM®) as a preset for quick tuning access.

Storing a Favorite

1. While listening to a desired channel (AM/FM/WB/SiriusXM®), press and hold  **FAVORITES** until the star icon turns solid.

Tuning to a Favorite

1. Press  **FAVORITES** to viewed stored presets.
2. Rotate **VOL/SEL** to highlight a desired preset; press to select.

Moving or Deleting a Favorite

1. Press  **FAVORITES** to viewed stored presets.
2. Rotate **VOL/SEL** clockwise to the **Favorites Edit: Select** menu and highlight a desired function; press to select.
3. Use **VOL/SEL** to select the preset to be moved or deleted.



Bluetooth® Audio

You may wirelessly stream audio from a Bluetooth® compatible device from up to 35 ft. away (11 m). Up to 8 devices can be paired to the MM100s, but only one streaming device can connect at one time.

Pairing a new device:

1. Press **SOURCE** on the MM100s to access the **SOURCE: Select** menu.
2. Rotate **VOL/SEL** to highlight **Bluetooth®** and press to select/enter **Pairing Mode**.
3. Enable Bluetooth® on your streaming device and scan for nearby devices; select JLA MM100s from your list of available devices to connect.

Once connected, you may control your audio selections with the MM100s using the controls below or directly from your device:

	Forward	• Press to select the next track
	Backward	• Press to select the previous track
	Mute/Pause/ Resume	• Press to pause or resume playing the current selection

Pairing additional devices:

1. Press **SOURCE** on the MM100s to access the **SOURCE: Select** menu.
2. Rotate **VOL/SEL** to highlight **Bluetooth®** and press to access the **Bluetooth: Connect Paired Device** menu.
3. Rotate **VOL/SEL** to highlight **Connect New Device**; press to enter Pairing Mode.
4. Enable Bluetooth® on your streaming device and scan for nearby devices; select JLA MM100s from your list of available devices to connect.





Managing Bluetooth® Devices:

You may manage paired devices or add new devices from the **Bluetooth: Main Menu**. To access the **Bluetooth: Main Menu**, press **BACK/MENU** while in Bluetooth® mode; then use the **VOL/SEL** to make your selections.

Connecting USB Devices

The USB port may be used to connect USB storage class devices (thumb drive, digital audio player, etc.). This USB connection also provides a 1A output for device charging. If this output is exceeded, an error message will display and the output will be disabled. Devices may be plugged directly into the USB port or use the JL Audio Combo 3.5 mm Audio Jack and 9 Wire USB Port for Panel-Mounting (XMD-USB/3.5MM-PNL). An appropriate USB cable for your device is required to make this input connection.

Once connected, press the **SOURCE** button and select **USB** from the **SOURCE: Select** menu to access the connected device with the following controls:

	Forward	<ul style="list-style-type: none">• Press to select the next track• Press and hold to fast-forward
	Backward	<ul style="list-style-type: none">• Press to select the previous track• Press and hold to fast-rewind
	Mute/Pause/ Resume	<ul style="list-style-type: none">• Press to pause or resume playing the current selection• Press and hold to access Shuffle and Repeat options from the USB: Play Options menu
	Back/Menu	<ul style="list-style-type: none">• Press to access the USB: Main Menu options• Press to go back or return to the Now Playing Screen





! IMPORTANT

- Properly secure the connected device before driving to prevent damage from dropping or sudden acceleration/braking.
- Control, functionality and display may vary depending on the type of device connected.
- Connections to computers or portable hard drives are not supported.
- Connections via USB hubs are not supported.

Connecting an iPhone®

An iPhone® may be connected to the USB port using an appropriate Lightning to USB cable (not included).

Once connected, press the **SOURCE** button and select **USB** from the **SOURCE: Select** menu to access the connected device with the following controls:

	Forward	<ul style="list-style-type: none">• Press to select the next track• Press and hold to fast-forward
	Backward	<ul style="list-style-type: none">• Press to select the previous track• Press and hold to fast-rewind
	Mute/Pause/ Resume	<ul style="list-style-type: none">• Press to pause or resume playing the current selection• Press and hold to access Shuffle and Repeat options from the USB: Play Options menu
 BACK/MENU	Back/Menu	<ul style="list-style-type: none">• Press to access the USB: Main Menu options• Press to go back or return to the Now Playing Screen
Compatible models include iPhone® 5, 5c, 5s, 6, 6s, 6+, and 6s+ (equipped with Lightning connector)		

! IMPORTANT

- Properly secure the connected device before driving to prevent damage from dropping or sudden acceleration/braking.
- Control, functionality and display may vary depending on the model and version of iPhone® connected.
- When connected via the USB port, make sure to unpair or disable the Bluetooth® connection to avoid possible playback conflicts.
- If you experience abnormal performance during operation, disconnect the iPhone® and check its condition. Restart your iPhone® if performance does not improve.
- “Made for iPhone” means that an electronic accessory has been designed to connect specifically to an iPhone® and has been certified by the developer to meet Apple performance standards. Apple is not responsible for the operation of this device or its compliance with safety and regulatory standards. Please note that the use of this accessory with an iPhone® may affect wireless performance.
- iPhone®, Lightning and all related marks and logos are trademarks of Apple Inc., registered in the U.S. and other countries.

SiriusXM® Satellite Radio

Only SiriusXM® brings you more of what you love to listen to, all in one place. Get over 140 channels, including commercial-free music plus the best sports, news, talk, comedy and entertainment. Welcome to the world of satellite radio. A SiriusXM® Connect Tuner, antenna and subscription are required. For more information, visit www.siriusxm.com.

Activating Your SiriusXM® Subscription

After installing your SiriusXM® Connect tuner and antenna, power ON your MM100s and select SiriusXM® as a source. You should be able to hear the SiriusXM® Preview channel on Channel 1. If you cannot hear the preview channel, please review the installation instructions to make sure your SiriusXM® Connect Tuner is properly installed.

After you can hear the Preview channel, tune to Channel 0 to find the Radio ID of your tuner. In addition, the Radio ID is located on the bottom of the SiriusXM® Connect Tuner and its packaging. You will need this number to activate your subscription. Write this number down for reference.

Note: the SiriusXM® Radio ID does not include the letters I, O, S or F.

Activate your SiriusXM® service online or by phone

For US Subscriptions:

- Visit www.siriusxm.com/activatenow
- Call SiriusXM® Listener Care at 1-866-635-2349

For Canadian Subscriptions:

- Visit www.siriusxm.ca/activatexm
- Call SiriusXM® Listener Care at 1-877-438-9677

As part of the activation process, the SiriusXM® satellites will send an activation message to your tuner. When your radio detects that the tuner has received the activation message, your radio will display: "Subscription Updated". Once subscribed, you can tune to channels in your subscription plan.

Note: The activation process usually takes 10 to 15 minutes, but may take up to an hour. Your radio will need to be powered ON and receiving the SiriusXM® signal to receive the activation message.

Listening to SiriusXM®

1. Press **SOURCE** and turn **VOL/SEL** to select SiriusXM.
2. Press **VOL/SEL** to begin listening to SiriusXM.

Channel Selection

1. Press **▶▶** or **◀◀** to select the next or previous channel.

Channel Browse

Channel Browse allows you to preview other channels without leaving your current channel.

1. Press and hold **▶▶** or **◀◀** to enter **Channel Browse** mode.
2. Press **▶▶** or **◀◀** to view what is playing on other channels. Hold **▶▶** or **◀◀** down to rapidly scroll through your available channels.
3. Press **VOL/SEL** to tune to the selected channel.

SiriusXM® Main Menu

The SiriusXM® Main Menu allows access to the following menu options:

Browse by Channel – Lists your available channels.

Browse by Category – Lists your available channels by categories.

My Account info – Lists your account status, Radio ID and Reset menu.

Parental Controls – Allows you to restrict channels containing mature content.

1. Press **BACK/MENU** to access the **SiriusXM®: Main Menu**.
2. Turn **VOL/SEL** to scroll through menu options.
3. Press **VOL/SEL** to make selections.

Parental Controls

Some SiriusXM® channels contain mature content. When the Parental Controls feature is enabled, channels with mature content are restricted and will require a 3-digit lock code to access.

Enabling Parental Controls

1. Press **BACK/MENU** to access the **SiriusXM®: Main Menu**.
2. Turn **VOL/SEL** to **Parental Controls** and press to enter.
3. Press **VOL/SEL** to select **Lock Mature Channels**. After, you may designate a 3-digit lock code to lock mature content channels.
4. Use **VOL/SEL** to enter a 3-digit lock code and select **Save** when finished. **Make sure to save your 3-digit lock code for future reference.**

Changing the Lock Code

1. Press **BACK/MENU** to access the **SiriusXM®: Main Menu**.
2. Turn **VOL/SEL** to **Parental Controls** and press to enter.
3. Turn **VOL/SEL** to **Edit Lock Code** and press enter.
4. Use **VOL/SEL** to enter the current 3-digit lock code and select **Enter** when finished.
5. Use **VOL/SEL** to enter the new lock code and select **Enter** to confirm. **Make sure to save your 3-digit lock code for future reference.**

Resetting SiriusXM® Radio Settings

A reset of the SiriusXM® tuner will erase all presets and settings, including parental controls, restoring all SiriusXM® settings back to their factory defaults.

1. Press **BACK/MENU** to access the **SiriusXM®: Main Menu**.
2. Turn **VOL/SEL** to **My Account** and press to enter.
3. Turn **VOL/SEL** to **Reset SiriusXM Tuner** and press to enter.
4. Use **VOL/SEL** to select **Confirm**.

Audio Zone Setup

The MM100s is equipped with four sets of low-voltage, line-level RCA outputs to send audio signals to your aftermarket amplifiers/equipment. Each output pair delivers full-range, low-distortion audio, arranged into four zones. Depending on your equipment and vessel, this will allow you to group speakers of an area together for flexibility and control of audio levels at separate zones. For example, you may prefer to reduce the listening level in an interior cabin, while keeping a louder audio level on the main deck.

Access the **Audio Zone Setup** menu to configure the functionality of each zone.

1. Press and hold **SETTINGS** to access the **System Settings: Main Menu**.
2. Press **VOL/SEL** to select **Audio Zone Setup**.
3. Use **VOL/SEL** to make selections.

Refer to the table below and following info for each zone's available settings and functionality.

Zone	Menu	Setting 1	Setting 2
Zone 1 (MAIN)	Primary Audio Zone	Start up Volume	
Zone 2	Level Control Mode	Full-Range Relative	
		Full-Range Absolute	Start up Volume
		Off	
	Tone Control Mode	Same as Main Zone	
		Independent Tone Control	
Zone 3 / Subwoofer	Level Control Mode	Subwoofer Relative*	
		Full-Range Relative	
		Full-Range Absolute	Start up Volume
		Off	
	Tone Control Mode	Same as Main Zone	
		Independent Tone Control	
Zone 4 (Fixed Level)	Selectable output voltage (4V, 2V, 1V or Off)		

* Renames the zone to "Subwoofer" in the Audio Zone Levels menu and displays it after Zone 1.

Level Control Mode Settings:

Start Up Volume: This setting determines the volume level when the unit is turned ON and can be useful in preventing sudden output bursts. Zone 1's Start up Volume setting is always available, while the Start up Volume settings for Zone 2 and Zone 3 are available only when their **Level Control Mode** is set to **Full-Range Absolute**.

Full-Range Relative: This setting is used to link the output level of Zone 2 or Zone 3 to the volume level of Zone 1.

When selected, Zone 2 or Zone 3's volume level will proportionally track Zone 1's volume. The offset level of volume can be adjusted from the **Audio Zone Levels** menu. To access the **Audio Zone Levels** menu, press and hold **VOL/SEL** from any Now Playing Screen. Use **VOL/SEL** to highlight a zone and press to select/make adjustments.

Full-Range Absolute: When selected, the output level of Zone 2 or Zone 3 will be independent, each with its own Start up Volume setting and separate

volume level slider, accessible from the **Audio Zone Levels** menu. To access the **Audio Zone Levels** menu, press and hold **VOL/SEL** from any Now Playing Screen. Use **VOL/SEL** to highlight a zone and press to select/make adjustments.

Tone Control Mode Settings:

Zone 1 (MAIN) tone controls can be accessed by pressing **SETTINGS**; use **VOL/SEL** to make adjustments.

Zone 2 and Zone 3 tone controls are available in two settings:

Same as Main Zone: The tone controls are linked to/controlled by Zone 1 (MAIN).

Independent Tone Controls: The tone controls are separate with independent adjustments that can be accessed from the **Audio Zone Levels** menu. To access the **Audio Zone Levels** menu, press and hold **VOL/SEL** from any Now Playing Screen. Use **VOL/SEL** to highlight a zone, then press **SETTINGS** to access its tone controls; use **VOL/SEL** to make adjustments.

Low Voltage Alert

A built-in alert is included to notify when the +12VDC supply voltage drops below 10 volts. If triggered, the unit will enter Safe Mode and mute audio output. A warning will also display on-screen with instructions to turn the unit off until normal operating voltage is restored.

1. Press and hold **SETTINGS** to access the **System Settings: Main Menu**.
2. Turn **VOL/SEL** to **Low Voltage Alert** and press to enter.
3. Turn **VOL/SEL** to select **ON** or **OFF** and press to enter.

Optional Remote Controller

Connecting an optional MMR-20 Wired Remote Controller (sold separately) will add auxiliary control functionality from extended locations, such as separate audio zones throughout a vessel. Up to three remotes may be connected to a single MediaMaster® at a maximum distance of 75 ft. Remotes connect directly using MediaMaster® controller cables and splitters (sold separately). Refer to the Owner's Manual supplied with the MMR-20 for specific installation and operation instructions.

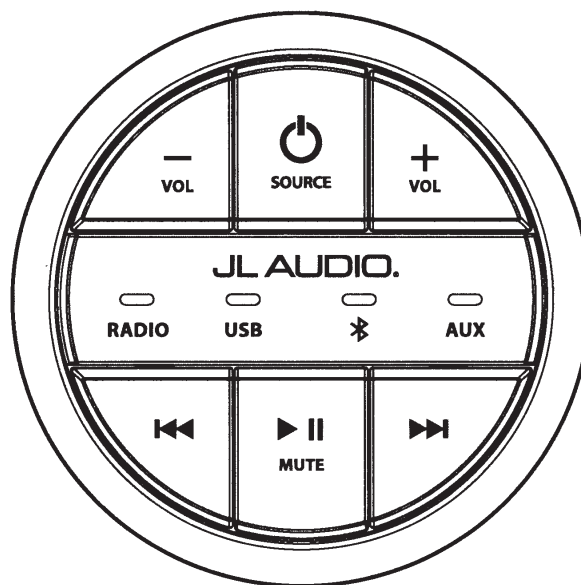

Troubleshooting

Problem	Possible Cause	Possible Solution
Unit doesn't turn on	Faulty fuse	Remove fuse and check with continuity meter. Replace if necessary.
	Poor connection integrity	Check "Ground" and "+12VDC" connections for pinched wires; ensure tight connections.
No or low sound	Mute is on	Press II to verify that Mute is not on.
	Volume is turned down	Rotate VOL/SEL to adjust volume.
Amps not turning on	Poor connection integrity	Check "Amp Turn-On" connections for pinched wires; ensure tight connections.
No or poor tuner reception	Poor connection integrity	Check antenna cable for pinched wires; ensure tight connections.
USB connection not working/charging	Poor connection integrity	Check USB cable for pinched wires; ensure tight connections.
SiriusXM		
Check Antenna	A fault has been detected with the SiriusXM antenna.	Ensure antenna cable is securely connected to the SiriusXM Connect Vehicle Tuner. Inspect the antenna cable for damage and kinks. Replace the antenna if the cable is damaged. SiriusXM products are available at your local audio retailer or online at www.shop.siriusxm.com .
Check SXM Tuner	The radio is having difficulty communicating with the SiriusXM Connect Vehicle Tuner.	Verify the SiriusXM Connect Tuner cable is securely connected to the radio.
No Signal	The SiriusXM Connect Tuner is having difficulty receiving the SiriusXM satellite signal.	Verify that your vehicle is outdoors with a clear view of the sky. Verify that the SiriusXM antenna is mounted securely to the outside of the vessel. Remove obstructions above or next to the SiriusXM antenna. Inspect antenna cable for damage and kinks. Consult the SiriusXM Connect Tuner installation manual for more information on antenna installation. Replace the antenna if the cable is damaged. SiriusXM products are available at your local audio retailer or online at www.shop.siriusxm.com .
Subscription Updated	The radio has detected a change in your SiriusXM subscription status. Press the BACK button to clear the message.	Visit www.siriusxm.com or call 866-635-2349 in the USA or 877-438-9677 in Canada if you have questions about your subscription.
Channel Not Available	The channel that you have requested is not a valid SiriusXM channel or the channel is no longer available. You may also see this message briefly when first connecting a new SiriusXM Connect Tuner.	Visit www.siriusxm.com for more information about the SiriusXM channel lineup.
Channel Not Subscribed	The channel that you have requested is not included in your SiriusXM subscription package or the channel that you were listening to is no longer included in your SiriusXM subscription package.	Visit www.siriusxm.com or call 866-635-2349 in the USA or 877-438-9677 in Canada if you have questions about your subscription package or would like to subscribe to this channel.
Channel Locked	The channel that you have requested is Locked by the radio Parental Control feature.	See page 15 for more information on the Parental Control feature and how to access locked channels.

Sirius XM Radio Inc. Sirius, XM and all related marks and logos are trademarks of Sirius XM Radio Inc.
 The Bluetooth® word mark and logos are registered trademarks owned by Bluetooth SIG, Inc.
 The aptX® word mark and logos are registered trademarks owned by CSR.
 iPhone® and Lightning are registered trademarks of Apple Inc.
 Use of all trademarks by JL Audio is under license.

Specifications

Electrical Specifications	
Operating Voltage	14.4V DC (10V – 15.9V allowable)
Maximum Current Draw	1.5 A
Standby Current Draw	120 mA
Fuse Value	5 A
Remote Turn-on Capacity	40 mA (max)
Operating Temp Range	-4 F to +158 F (-20 C to +70 C)
Display	
Size / Type	3.5-inch / TFT LCD backlighted
Resolution	320 x 240
Audio Outputs/Inputs	
Output Channels	4 stereo pairs of RCA plugs (3 variable + 1 fixed level)
Output Zones	1 main zone (variable), 2 assignable zones (variable) and 1 fixed level zone
Maximum Output Voltage	4V RMS (zones 1/2/3), selectable 4V/2V/1V RMS (zone 4)
Output Impedance	250 ohm
Input Channels	1 stereo pair of RCA plugs (2V/1V RMS input sensitivity)
Tuner	
FM Tuner with RDS	87.5 MHz to 107.9 MHz (0.2 MHz step)
AM Tuner	530 kHz to 1710 kHz (10 kHz step)
NOAA Weather Band Tuner	162.400 MHz to 162.550 MHz (0.025 MHz step)
Favorites	18 presets across all tuners
Bluetooth®	
Profile	A2DP v1.2, AVRCP v1.4
Core Specification	Version 2.1 + EDR
Codec	SBC, aptX®
Connection Range	Up to 35 ft / 11 m
USB	
Interface	USB 2.0 host
Maximum Current Output	1 A
Supported Audio Formats	MP3, WAV, WMA
iPhone® Compatibility	5, 5c, 5s, 6, 6+, 6s, 6s+ (all Lightning connector models)
Dimensions	
Unit W x H x D	5.94 in. x 3.90 in. x 3.17 in. (151 mm x 99 mm x 80.5 mm)
Mounting Hole W x H	4.70 in. x 3.25 in. (119.50 mm x 82.50 mm)

Limited Warranty – Electronics (USA)

JL Audio warrants this product to be free of defects in materials and workmanship for a period of **two (2) years** from the original date of purchase.

This warranty is not transferable and applies only to the original purchaser from an authorized JL Audio dealer. Should service be necessary under this warranty for any reason due to manufacturing defect or malfunction, JL Audio will (at its discretion), repair or replace the defective product with new or remanufactured product at no charge. Damage caused by the following is not covered under warranty: accident, misuse, abuse, product modification or neglect, failure to follow installation instructions, unauthorized repair attempts, misrepresentations by the seller. This warranty does not cover incidental or consequential damages and does not cover the cost of removing or reinstalling the unit(s). Cosmetic damage due to accident or normal wear and tear is not covered under warranty.

Warranty is void if the product's serial number has been removed or defaced.

Any applicable implied warranties are limited in duration to the period of the express warranty as provided herein beginning with the date of the original purchase at retail, and no warranties, whether express or implied, shall apply to this product thereafter. Some states do not allow limitations on implied warranties, therefore these exclusions may not apply to you. This warranty gives you specific legal rights, and you may also have other rights, which vary from state to state.

If you need service on your JL AUDIO product:

All warranty returns should be sent to JL Audio 's Electronics Service Facility freight-prepaid through an authorized JL Audio dealer and must be accompanied by proof of purchase (a copy of the original sales receipt). Direct returns from consumers or non-authorized dealers will be refused unless specifically authorized by JL Audio with a valid return authorization number. Warranty expiration on products returned without proof of purchase will be determined from the manufacturing date code. Coverage may be invalidated as this date is previous to purchase date. Non-defective items received will be returned freight-collect. Customer is responsible for shipping charges and insurance in sending the product to JL Audio. Freight damage on returns is not covered under warranty.

For Service Information in the U.S.A. please call

JL Audio Customer Service:

(954) 443-1100

9:00 AM – 5:30 PM (Eastern Time Zone)

JL Audio, Inc.

10369 North Commerce Pkwy.

Miramar, FL 33025

(Do not send product for repair to this address)

International Warranties:

Products purchased outside the United States of America are covered only by that country's distributor and not by JL Audio, Inc.

+

+

+

+